

Kingbright®

2.0x1.2mm SUPER THIN SMD CHIP LED LAMPS

KPT-2012 SERIES

Features

- 2.0mmx1.2mm SMT LED. 0.75mm THICKNESS.
- LOW POWER CONSUMPTION.
- WIDE VIEWING ANGLE.
- IDEAL FOR BACKLIGHT AND INDICATOR.
- VARIOUS COLORS AND LENS TYPES AVAILABLE.

Description

The Bright Red source color devices are made with Gallium Phosphide Red Light Emitting Diode.

The Super Bright Green source color devices are made with Gallium Phosphide Green Light Emitting Diode.

The High Efficiency Red source color devices are made with Gallium Arsenide Phosphide on Gallium Phosphide Orange Light Emitting Diode.

The Yellow source color devices are made with Gallium Arsenide Phosphide on Gallium Phosphide Yellow Light Emitting Diode.

The Super Bright Red source color devices are made with Gallium Aluminum Arsenide Red Light Emitting Diodes.

The Super Bright Yellow source color devices are made with DH InGaAlP on GaAs substrate Light Emitting Diode.

Package Dimensions

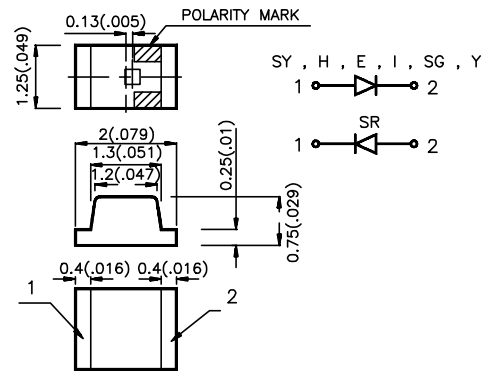

- Notes:
1. All dimensions are in millimeters (inches).
 2. Tolerance is $\pm 0.1(0.004)$ unless otherwise noted.
 3. Lead spacing is measured where the lead emerge package.
 4. Specifications are subjected to change without notice.

Selection Guide

Part No.	Dice	Lens Type	Iv (mcd) @ 20 mA		Viewing Angle $2\theta_{1/2}$
			Min.	Typ.	
KPT-2012HD	BRIGHT RED (GaP)	RED DIFFUSED	0.8	1.25	120°
KPT-2012HC	BRIGHT RED (GaP)	WATER CLEAR	0.8	1.25	120°
KPT-2012HT	BRIGHT RED (GaP)	RED TRAS.	0.8	1.25	120°
KPT-2012ID	HIGH EFFICIENCY RED (GaAsP/GaP)	RED DIFFUSED	5	12.5	120°
KPT-2012EC	HIGH EFFICIENCY RED (GaAsP/GaP)	WATER CLEAR	5	12.5	120°
KPT-2012IT	HIGH EFFICIENCY RED (GaAsP/GaP)	RED TRANS.	5	12.5	120°
KPT-2012YD	YELLOW (GaAsP/GaP)	YELLOW DIFFUSED	3.2	8	120°
KPT-2012YC	YELLOW (GaAsP/GaP)	WATER CLEAR	3.2	8	120°
KPT-2012YT	YELLOW (GaAsP/GaP)	YELLOW TRANS.	3.2	8	120°
KPT-2012SRD	SUPER BRIGHT RED (GaAlAs)	RED DIFFUSED	40	70	120°
KPT-2012SRC	SUPER BRIGHT RED (GaAlAs)	WATER CLEAR	40	70	120°
KPT-2012SRT	SUPER BRIGHT RED (GaAlAs)	RED TRANS.	40	70	120°
KPT-2012SGD	SUPER BRIGHT GREEN (GaP)	GREEN DIFFUSED	3.2	12.5	120°
KPT-2012SGC	SUPER BRIGHT GREEN (GaP)	WATER CLEAR	3.2	12.5	120°
KPT-2012SGT	SUPER BRIGHT GREEN (GaP)	GREEN TRNS.	3.2	12.5	120°
KPT-2012SYD	SUPER BRIGHT YELLOW (InGaAlP)	YELLOW DIFFUSED	40	60	120°
KPT-2012SYC	SUPER BRIGHT YELLOW (InGaAlP)	WATER CLEAR	40	60	120°
KPT-2012SYT	SUPER BRIGHT YELLOW (InGaAlP)	YELLOW TRNS.	40	60	120°

Note:
1. $\theta_{1/2}$ is the angle from optical centerline where the luminous intensity is 1/2 the optical centerline value.

Electrical / Optical Characteristics at T_A=25°C

Symbol	Parameter	Device	Typ.	Max.	Units	Test Conditions
λ_{peak}	Peak Wavelength	Bright Red High Efficiency Red Yellow Super Bright Red Super Bright Green Super Bright Yellow	700 625 590 660 565 595		nm	IF=20mA
$\Delta\lambda_{1/2}$	Spectral Line Halfwidth	Bright Red High Efficiency Red Yellow Super Bright Red Super Bright Green Super Bright Yellow	45 45 35 20 30 20		nm	IF=20mA
C	Capacitance	Bright Red High Efficiency Red Yellow Super Bright Red Super Bright Green Super Bright Yellow	40 12 10 95 45 33		pF	VF=0V;f=1MHz
V _F	Forward Voltage	Bright Red High Efficiency Red Yellow Super Bright Red Super Bright Green Super Bright Yellow	2.0 2.0 2.1 1.85 2.2 2.0	2.5 2.5 2.5 2.5 2.5 2.4	V	IF=20mA
I _R	Reverse Current	All	10		uA	VR = 5V

Absolute Maximum Ratings at T_A=25°C

Parameter	Bright Red	High Efficiency Red	Yellow	Super Bright Red	Super Bright Green	Super Bright Yellow	Units
Power dissipation	105	105	105	100	105	125	mW
DC Forward Current	25	30	30	30	25	30	mA
Peak Forward Current [1]	150	150	150	150	150	150	mA
Reverse Voltage	5	5	5	5	5	5	V
Operating/Storage Temperature	-40 °C To +85 °C						

Note:
1. 1/10 Duty Cycle, 0.1ms Pulse Width.

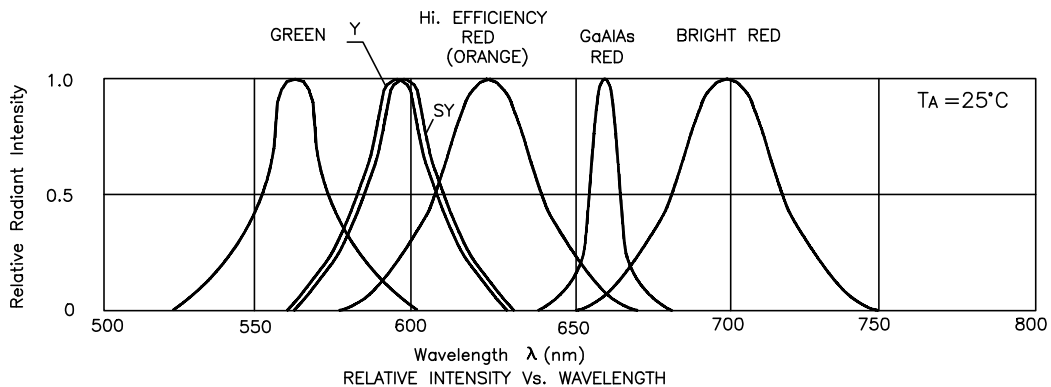

Bright Red KPT-2012HD, KPT-2012HC, KPT-2012HT

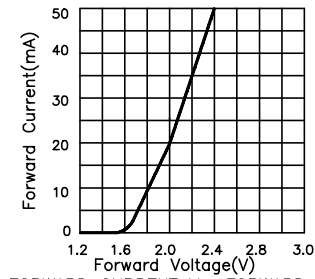

FORWARD CURRENT Vs. FORWARD VOLTAGE

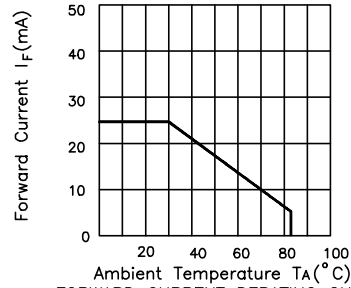

FORWARD CURRENT DERATING CURVE

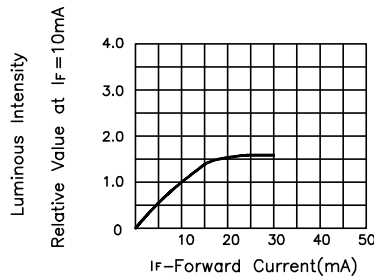

LUMINOUS INTENSITY Vs. FORWARD CURRENT

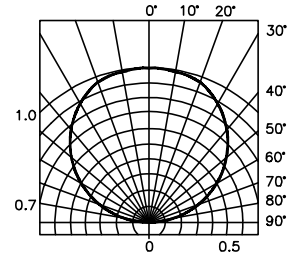

SPATIAL DISTRIBUTION

High Efficiency Red KPT-2012ID, KPT-2012EC, KPT-2012IT

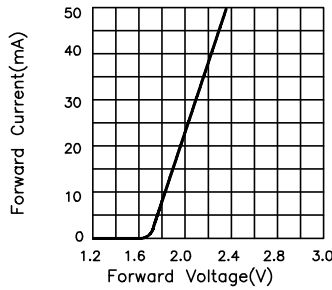

FORWARD CURRENT Vs. FORWARD VOLTAGE

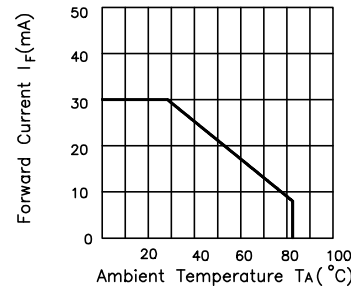

FORWARD CURRENT DERATING CURVE

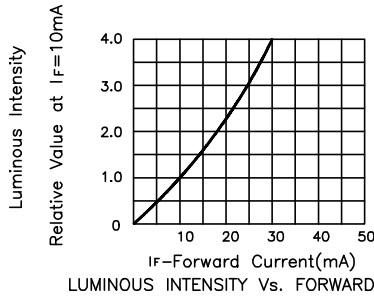

LUMINOUS INTENSITY Vs. FORWARD CURRENT

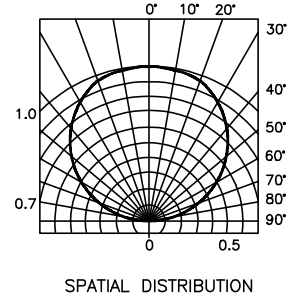

SPATIAL DISTRIBUTION

Yellow KPT-2012YD, KPT-2012YC, KPT-2012YT

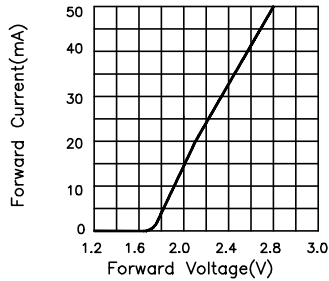

FORWARD CURRENT Vs. FORWARD VOLTAGE

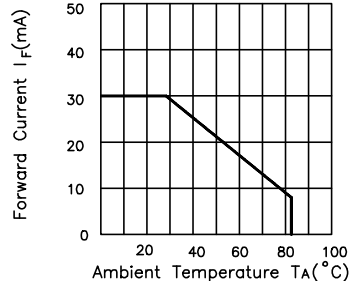

FORWARD CURRENT DERATING CURVE

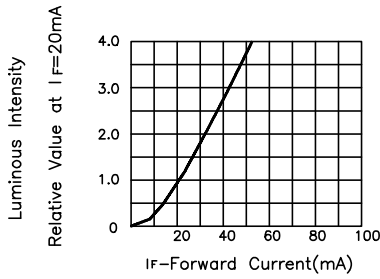

I_F -Forward Current (mA)

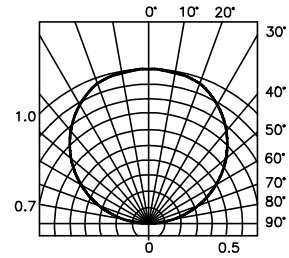

SPATIAL DISTRIBUTION

Super Bright Red KPT-2012SRD, KPT-2012SRC, KP-2012SRT

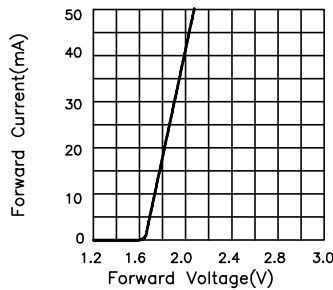

FORWARD CURRENT Vs. FORWARD VOLTAGE

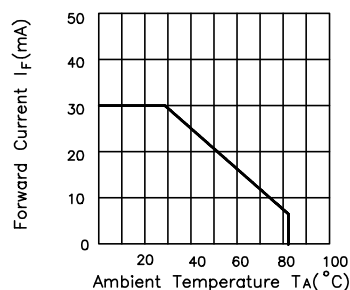

FORWARD CURRENT DERATING CURVE

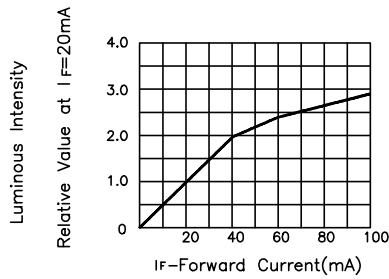

LUMINOUS INTENSITY Vs. FORWARD CURRENT

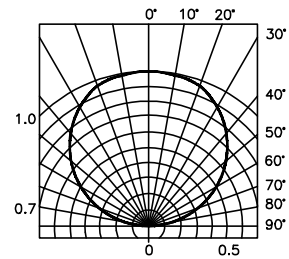

SPATIAL DISTRIBUTION

Super Bright Green KPT-2012SGD, KPT-2012SGC, KPT-2012SGT

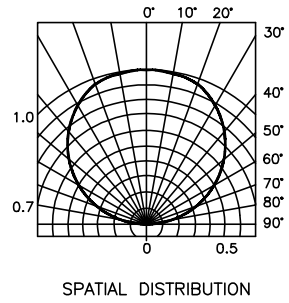
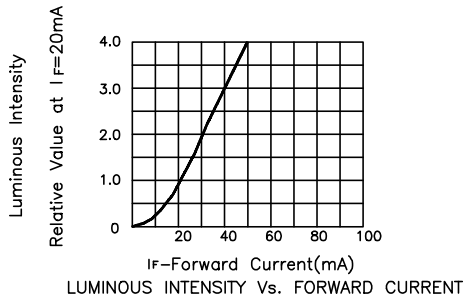
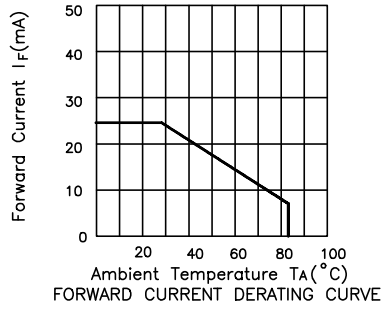
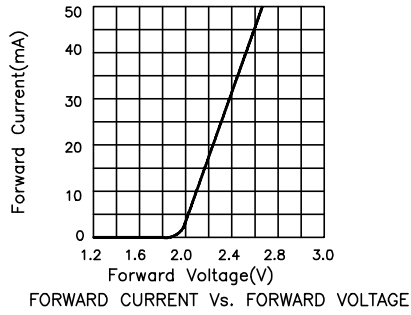

Super Bright Yellow KPT-2012SYD, KPT-2012SYC, KPT-2012SYT

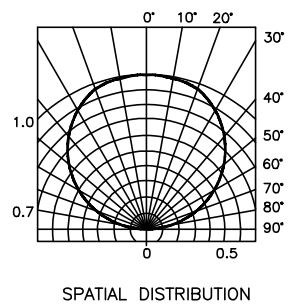
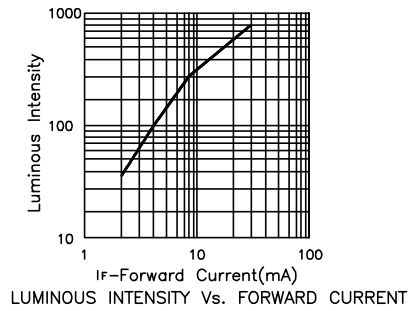
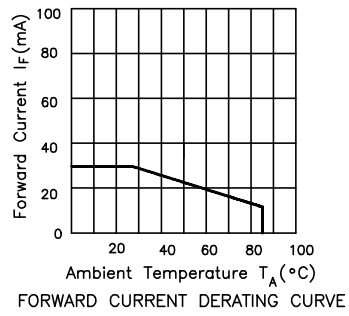
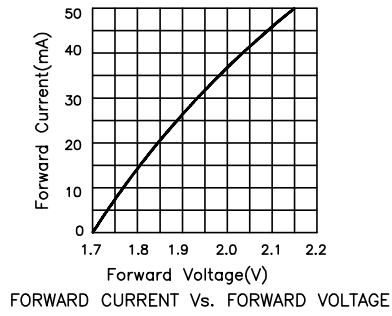

KPT-2012 Series SMT Reflow Soldering Instructions

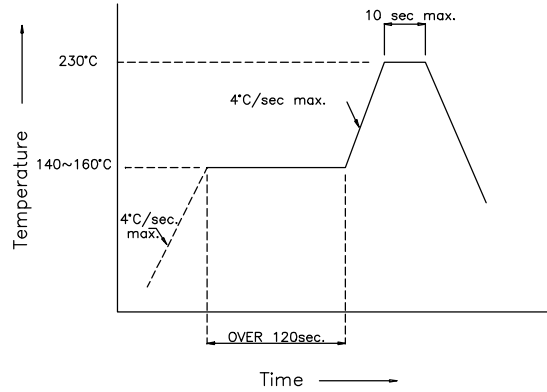

KPT-2012 Series Recommended Soldering Pattern

(Units : mm)

FOR REFLOW SOLDERING

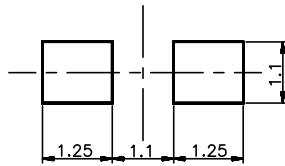

KPT-2012 Series Tape Specifications

