

International  
**IR** Rectifier

# 15MQ040N

## SCHOTTKY RECTIFIER

## 3 Amp

$$I_{F(AV)} = 3 \text{ Amp}$$

$$V_R = 40V$$

### Major Ratings and Characteristics

Characteristics	15MQ040N	Units
$I_F$ DC	3	A
$V_{RRM}$	40	V
$I_{FSM}$ @ $t_p = 5 \mu s$ sine	330	A
$V_F$ @ $2A_p, T_J = 125^\circ C$	0.43	V
$T_J$ range	-40 to 150	$^\circ C$

### Description/ Features

The 15MQ040N Schottky rectifier is designed to be used for low-power applications where a reverse voltage of 40 volts is encountered and surface mountable is required.

### Applications

- Switching power supplies
- Meter protection
- Reverse protection for power input to PC board circuits
- Battery isolation and charging
- Low threshold voltage diode
- Free-wheeling or by-pass diode
- Low voltage clamp

### Features

- Surface mountable
- Extremely low forward voltage
- Improved reverse blocking voltage capability relative to other similar size Schottky
- Compact size

### Case Styles

15MQ040N

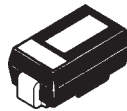

SMA



## Voltage Ratings

Part number	15MQ040N
$V_R$ Max. DC Reverse Voltage (V)	40
$V_{RWM}$ Max. Working Peak Reverse Voltage (V)	

## Absolute Maximum Ratings

Parameters	15MQ	Units	Conditions
$I_{F(AV)}$ Max. Average Forward Current * See Fig. 4	2.1	A	50% duty cycle @ $T_L = 105^\circ\text{C}$ , rectangular wave form. On PC board 9mm <sup>2</sup> island (.013mm thick copper pad area)
$I_{FSM}$ Max. Peak One Cycle Non-Repetitive Surge Current * See Fig. 6	330	A	Following any rated load condition and with rated $V_{RWM}$ applied
	140		
$E_{AS}$ Non-Repetitive Avalanche Energy	6.0	mJ	$T_J = 25^\circ\text{C}$ , $I_{AS} = 1\text{A}$ , $L = 12\text{mH}$
$I_{AR}$ Repetitive Avalanche Current	1.0	A	

## Electrical Specifications

Parameters	15MQ	Units	Conditions
$V_{FM}$ Max. Forward Voltage Drop (1) * See Fig. 1	0.42	V	@ 1A
	0.49	V	@ 2A
	0.34	V	@ 1A
	0.43	V	@ 2A
$I_{RM}$ Max. Reverse Leakage Current (1) * See Fig. 2	0.5	mA	$T_J = 25^\circ\text{C}$
	20	mA	$T_J = 125^\circ\text{C}$
$V_{F(TO)}$ Threshold Voltage	0.26	V	$T_J = T_J \text{ max.}$
$r_t$ Forward Slope Resistance	64.6	m $\Omega$	
$C_T$ Typical Junction Capacitance	134	pF	$V_R = 10V_{DC}$ , $T_J = 25^\circ\text{C}$ , test signal = 1Mhz
$L_S$ Typical Series Inductance	2.0	nH	Measured lead to lead 5mm from package body
$dv/dt$ Max. Voltage Rate of Change	10000	V/ $\mu\text{s}$	(Rated $V_R$ )

(1) Pulse Width < 300 $\mu\text{s}$ , Duty Cycle < 2%

## Thermal-Mechanical Specifications

Parameters	15MQ	Units	Conditions
$T_J$ Max. Junction Temperature Range (*)	-40 to 150	$^\circ\text{C}$	
$T_{stg}$ Max. Storage Temperature Range	-40 to 150	$^\circ\text{C}$	
$R_{thJA}$ Max. Thermal Resistance Junction to Ambient	80	$^\circ\text{C/W}$	DC operation
wt Approximate Weight	0.07(0.002)	g(oz.)	
Case Style	SMA		Similar D-64
Device Marking	IR3F		

(\*)  $\frac{dP_{tot}}{dT_J} < \frac{1}{R_{th(j-a)}}$  thermal runaway condition for a diode on its own heatsink

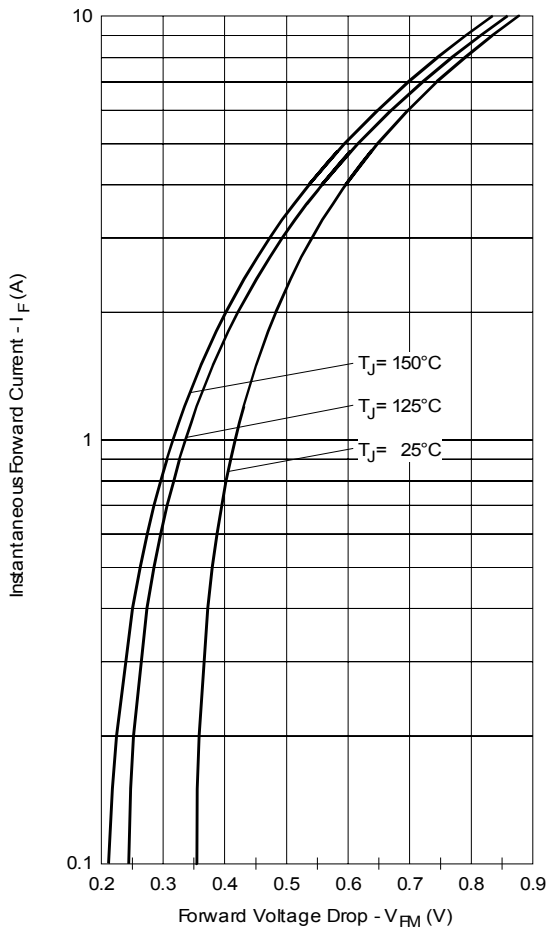

Fig. 1 - Maximum Forward Voltage Drop Characteristics

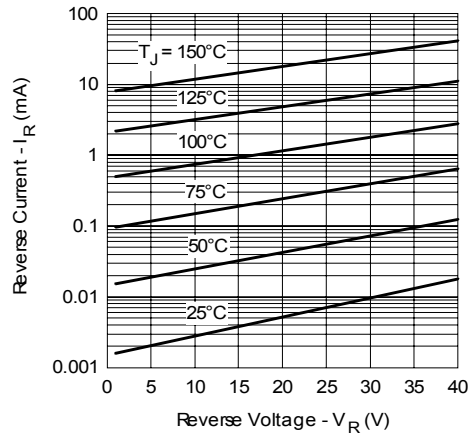

Fig. 2 - Typical Peak Reverse Current Vs. Reverse Voltage

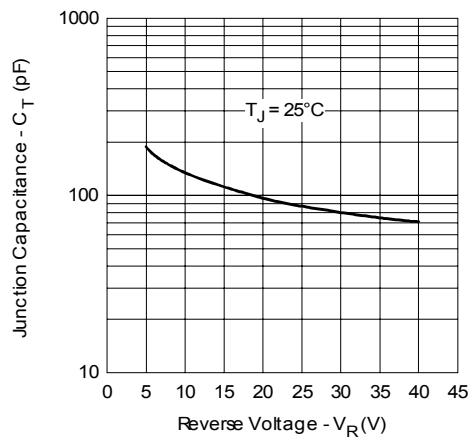

Fig. 3 - Typical Junction Capacitance Vs. Reverse Voltage

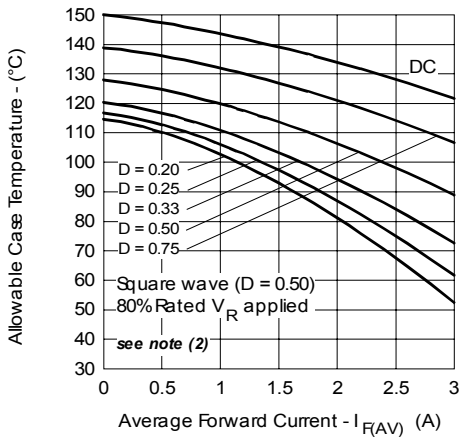

Fig. 4 - Maximum Average Forward Current Vs. Allowable Lead Temperature

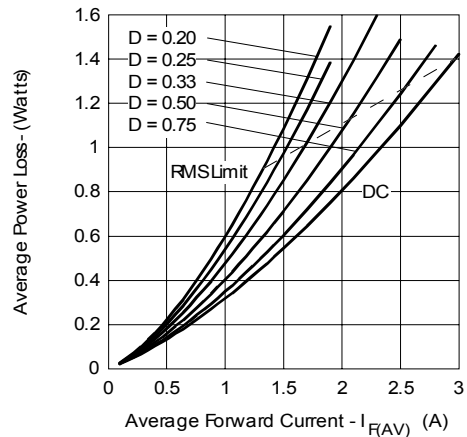

Fig. 5 - Maximum Average Forward Dissipation Vs. Average Forward Current

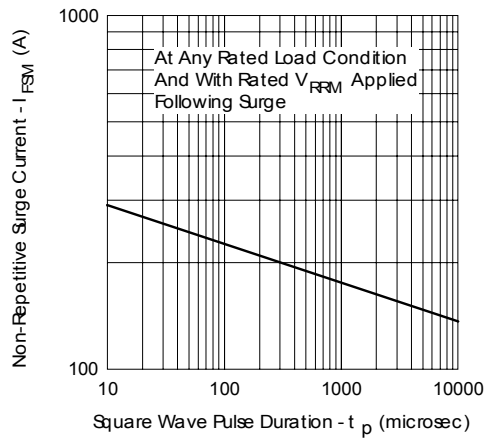

Fig. 6 - Maximum Peak Surge Forward Current Vs. Pulse Duration

(2) Formula used:  $T_c = T_j - (Pd + Pd_{REV}) \times R_{thJC}$ ;

$Pd$  = Forward Power Loss =  $I_{F(AV)} \times V_{FM} @ (I_{F(AV)} / D)$  (see Fig. 6);

$Pd_{REV}$  = Inverse Power Loss =  $V_{R1} \times I_R (1 - D)$ ;  $I_R @ V_{R1} = 80\%$  rated  $V_R$

Outline Table

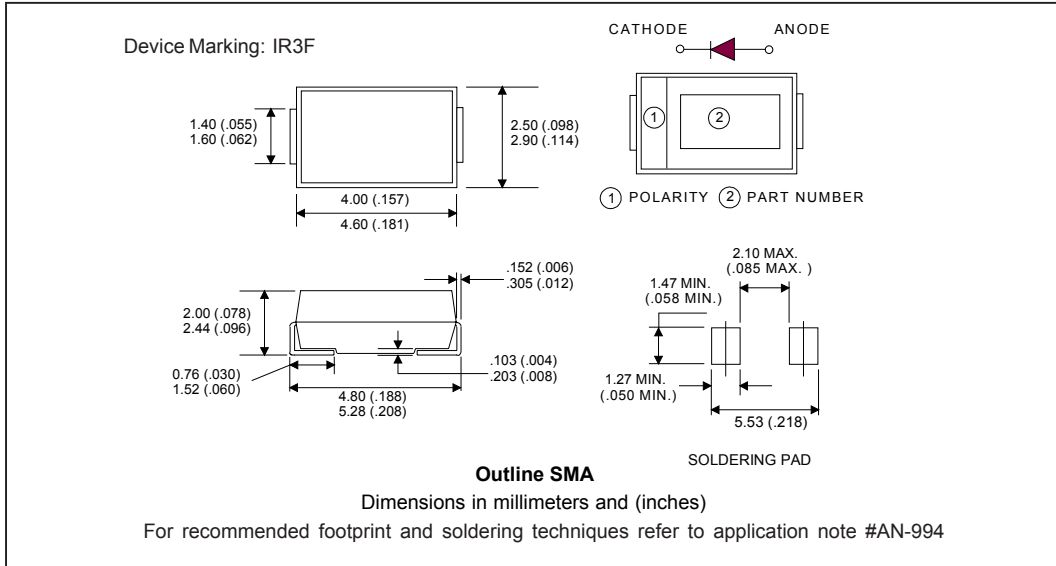

Marking & Identification

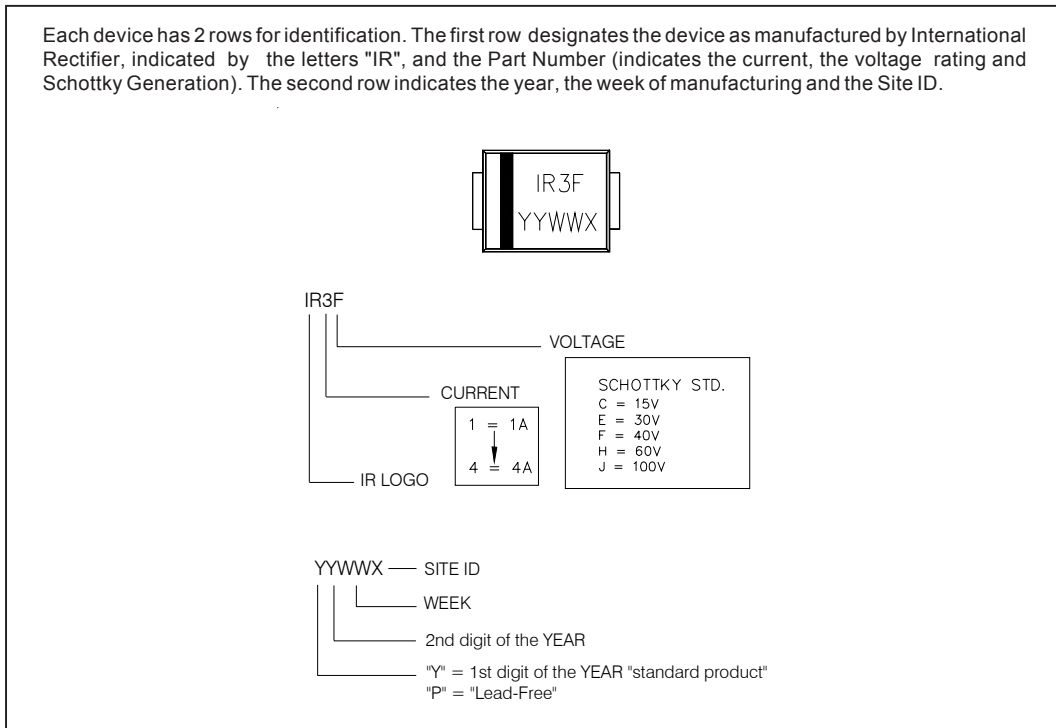

Tape & Reel Information

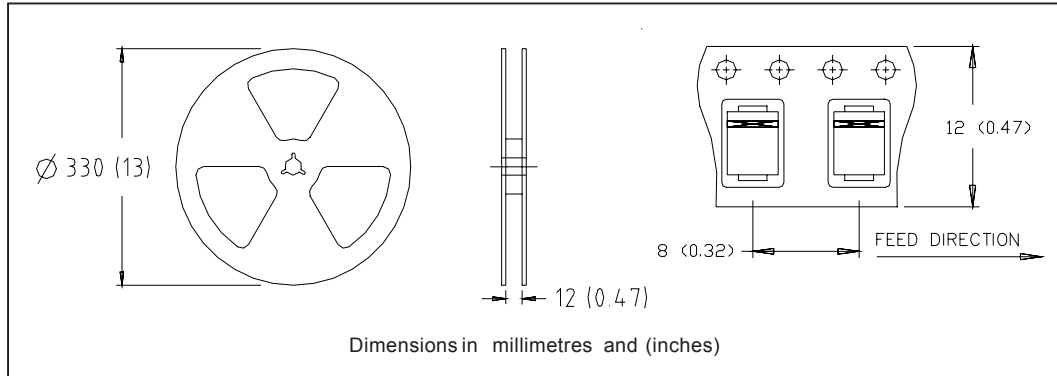

Ordering Information Table

Device Code						
<b>15</b>	<b>M</b>	<b>Q</b>	<b>040</b>	<b>N</b>	<b>TR</b>	<b>-</b>
①	②	③	④	⑤	⑥	⑦
<b>1</b>	- Current Rating					
<b>2</b>	- M = SMA					
<b>3</b>	- Q = Schottky Q Series					
<b>4</b>	- Voltage Rating (040 = 40V)					
<b>5</b>	- N = New SMA					
<b>6</b>	- • none = Box (1000 pieces) • TR = Tape & Reel (7500 pieces)					
<b>7</b>	- • none = Standard Production • PbF = Lead-Free					

Data and specifications subject to change without notice.  
This product has been designed and qualified for Industrial Level.  
Qualification Standards can be found on IR's Web site.